

A-A (1:1)

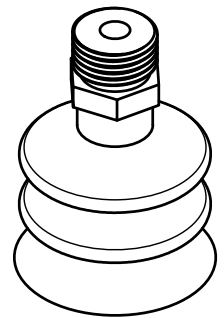

Info :

***= PAR=Para
SIL=Silicone
NIT=Nitrile

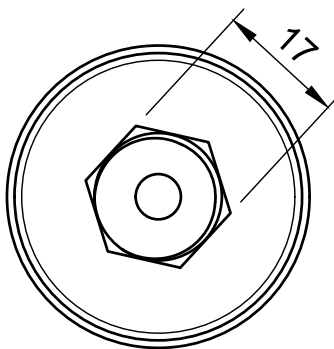
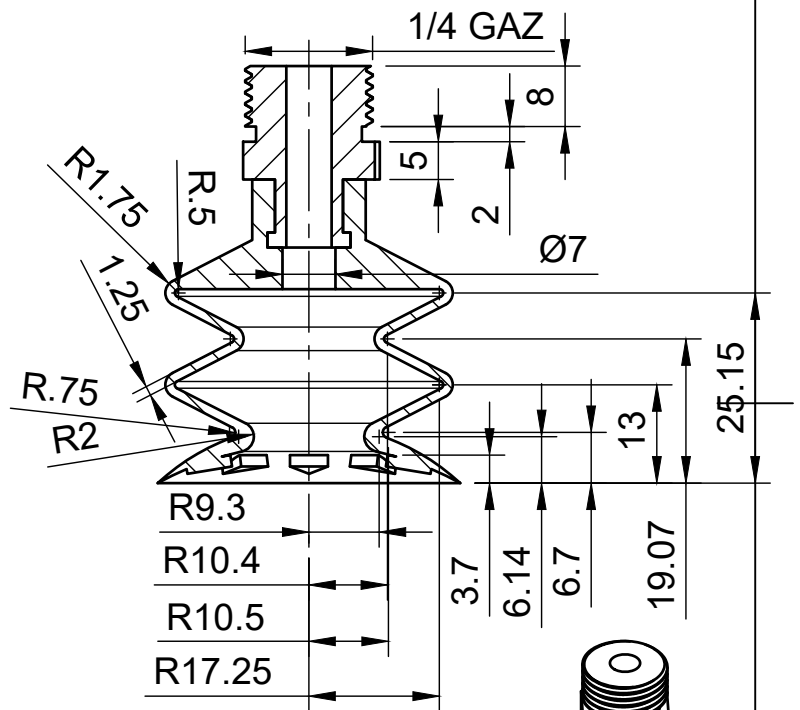
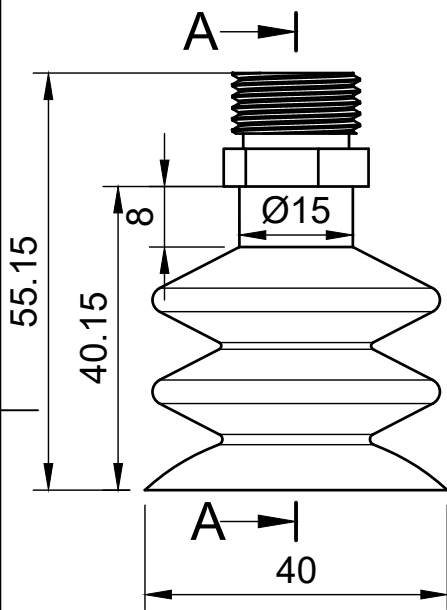

Créé par : B.E CPDN

Matière : ***

Désignation :
Ventouse D40 2 soufflet 1/2
insert mâle 3/8gaz

Référence :
60140/40/2S/***/M38LAI

Echelle :
1:1

Date :
07/07/2020

Indice :
1